

Technics

Stereo Double Cassette Deck RS-TR979/RS-TR777

Operating Instructions



The photograph shows the RS-TR979 model.

Notes:

- Specifications differ according to the area code.
- The "EB" area code, for example, indicates United Kingdom specifications.
- The "EB" indication is shown on the packing case.

Before operating this unit, please read these instructions completely.

Dear Stereo Fan

We want to thank you for selecting this product and to welcome you to the growing family of satisfied Technics product owners around the world. We feel certain you will get maximum enjoyment

from this new addition to your home. Please read these operating instructions carefully, and be sure to keep them handy for convenient reference.

These operating instructions are applicable to the RS-TR979 and RS-TR777 models. These operating instructions, however, primarily explain the operation of the RS-TR979 model.

Contents

• Accessories	2	• Convenient Features for Recording	17
• Caution for AC mains lead (For United Kingdom)	3	• Timer Recording/Playback	18
• Suggestions for Safety	4	• After Recording	19
• Connections	5	• About the Quick-Reverse Function	19
• Front Panel Controls and Functions	6	• About Cassette Tapes	20
• Playback	9	• Maintenance	20
• Recording	12	• Troubleshooting Guide	21
• Tape-to-tape Recording	16	• Technical Specifications	22

For areas except United Kingdom, Europe, Australia and N.Z.

CAUTION:

The AC voltage is different according to the area.
Be sure to set the proper voltage in your area before use.
(For details, please refer to the page 5.)

Accessories

Configuration of AC power supply cord differs according to area.

- AC power supply cord

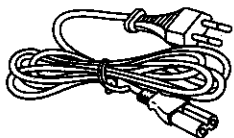

- L-type cables

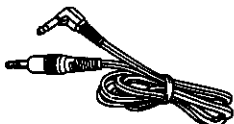

- Stereo connection cables

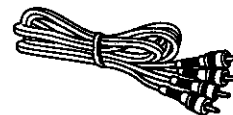

- Power plug adaptor
- (Not supplied for United Kingdom, Europe, Australia and N.Z.)



Caution for AC mains lead

(For United Kingdom)

("EB" area code model only)

For your safety, please read the following text carefully.

This appliance is supplied with a moulded three pin mains plug for your safety and convenience.

A 5-ampere fuse is fitted in this plug.

Should the fuse need to be replaced please ensure that the replacement fuse has a rating of 5-ampere and that it is approved by ASTA or BSI to BS1362.

Check for the ASTA mark  or the BSI mark  on the body of the fuse.

If the plug contains a removable fuse cover you must ensure that it is refitted when the fuse is replaced.

If you lose the fuse cover the plug must not be used until a replacement cover is obtained.

A replacement fuse cover can be purchased from your local dealer.

CAUTION!

IF THE FITTED MOULDED PLUG IS UNSUITABLE FOR THE SOCKET OUTLET IN YOUR HOME THEN THE FUSE SHOULD BE REMOVED AND THE PLUG CUT OFF AND DISPOSED OF SAFELY.

THERE IS A DANGER OF SEVERE ELECTRICAL SHOCK IF THE CUT OFF PLUG IS INSERTED INTO ANY 13-AMPERE SOCKET.

If a new plug is to be fitted please observe the wiring code as shown below.

If in any doubt please consult a qualified electrician.

IMPORTANT

The wires in this mains lead are coloured in accordance with the following code:

Blue: Neutral

Brown: Live

As the colours of the wires in the mains lead of this appliance may not correspond with the coloured markings identifying the terminals in your plug, proceed as follows:

The wire which is coloured BLUE must be connected to the terminal in the plug which is marked with the letter N or coloured BLACK.

The wire which is coloured BROWN must be connected to the terminal in the plug which is marked with the letter L or coloured RED.

Under no circumstances should either of these wires be connected to the earth terminal of the three pin plug, marked with the letter E or the Earth Symbol .

Before use

Remove the connector cover as follows.

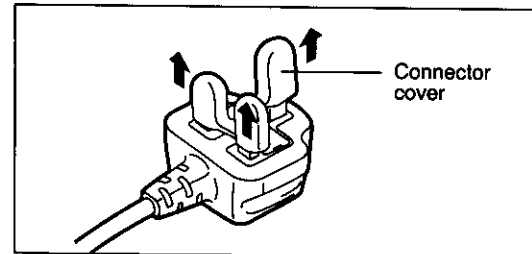

How to replace the fuse

1. Remove the fuse cover with a screwdriver.

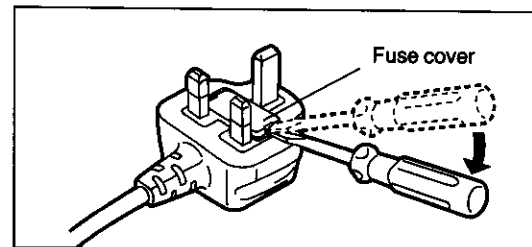

2. Replace the fuse and attach the fuse cover.

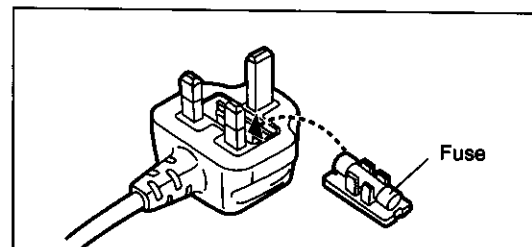

Suggestions for Safety

■ Use a standard AC wall outlet

1. **Use from an AC power source of high voltage, such as for an air conditioner, is very dangerous.**

There is the possibility that a fire might be caused by making such a connection.

2. **A DC power source cannot be used.**

Be sure to check the power source carefully, especially on a ship or other place where DC is used.

■ Grasp the plug when disconnecting the power supply cord

1. **Wet hands are dangerous.**

A dangerous electric shock may result if the plug is touched by wet hands.

2. **Never place heavy items on top of the power supply cord, and never force it to bend sharply.**

■ Place the unit where it will be well ventilated

Place this unit at least 10 cm (4") away from wall surfaces, etc.

■ Avoid places such as the following:

In direct sunlight or in other places where the temperature is high.

In places where there is excessive vibration or humidity.

Such conditions might damage the cabinet and/or other component parts and thereby shorten the unit's service life.

■ Be sure to place the unit on a flat, level surface.

If the surface is inclined, a malfunction may result.

■ Never attempt to repair or reconstruct this unit

A serious electric shock might occur if this unit is repaired, disassembled or reconstructed by unauthorized persons, or if the internal parts are accidentally touched.

■ Take particular care if children are present

Never permit children to put anything, especially metal, inside this unit. A serious electric shock or malfunction could occur if articles such as coins, needles, screwdrivers, etc. are inserted through the ventilation holes, etc. of this unit.

■ If water is spilled on the unit

Be extremely careful if water is spilled on the unit, because a fire or serious electric shock might occur. Immediately disconnect the power cord plug, and consult with your dealer.

■ Avoid spray-type insecticides

Insecticides might cause cracks or "cloudiness" in the cabinet and plastic parts of this unit. The gas used in such sprays might, moreover, be ignited suddenly.

■ Never use alcohol or paint thinner

These and similar chemicals should never be used, because they might cause flaking or cloudiness of the cabinet finish.

■ Disconnect the power supply cord if the unit will not be used for a long time

If the unit is left for a long time with the power ON, this will not only shorten its useful operation life, but may also cause other troubles.

■ If trouble occurs

If, during operation, the sound is interrupted or indicators no longer illuminate, or if abnormal odor or smoke is detected, immediately disconnect the power cord plug, and contact your dealer or an Authorized Service Center.

Connections

Make connections in the numbered sequence by using the included cables.

The illustration at the right shows an example of connections made when this unit is combined with a Technics hi-fi component system, and shows only the connections to be made to and from this unit in that combination. Refer to the illustration together with the instructions provided below.

Note:

Avoid letting the cables touch each other as much as possible, otherwise noise will be generated.

1 Connect the stereo connection cables.

2 Connect the L-type cables.

3 Set the power voltage.

(For areas except United Kingdom, Europe, Australia and N.Z.)

Set the voltage selector to the voltage setting for the area in which the unit will be used.

[Use a minus (-) screwdriver]

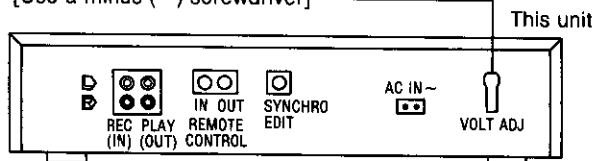

Note: Note that this unit will be seriously damaged if this setting is not made correctly.

FOR UNITED KINGDOM ONLY
BE SURE TO READ THE CAUTION FOR AC
POWER SUPPLY CORD ON PAGE 3 BEFORE
PROCEEDING TO THE STEP 4 .

4 Connect the AC power supply cord after you have connected all other cables and cords.

The configuration of the AC outlet and AC power supply cord differs according to area.

(For areas except Australia and N.Z.)

Insertion of Connector

Even when the connector is perfectly inserted, depending on the type of inlet used, the front part of the connector may jut out as shown in the drawing.

However there is no problem using the unit.

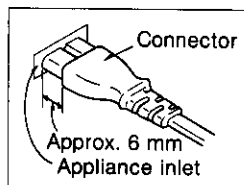

Placements hints

If this unit is placed near a receiver or a tuner, a "hum" noise may be heard during tape playback, recording, or AM reception of the receiver or the tuner.

If this occurs, leave as much space as possible between the units, or place them where there is the least amount of "hum".

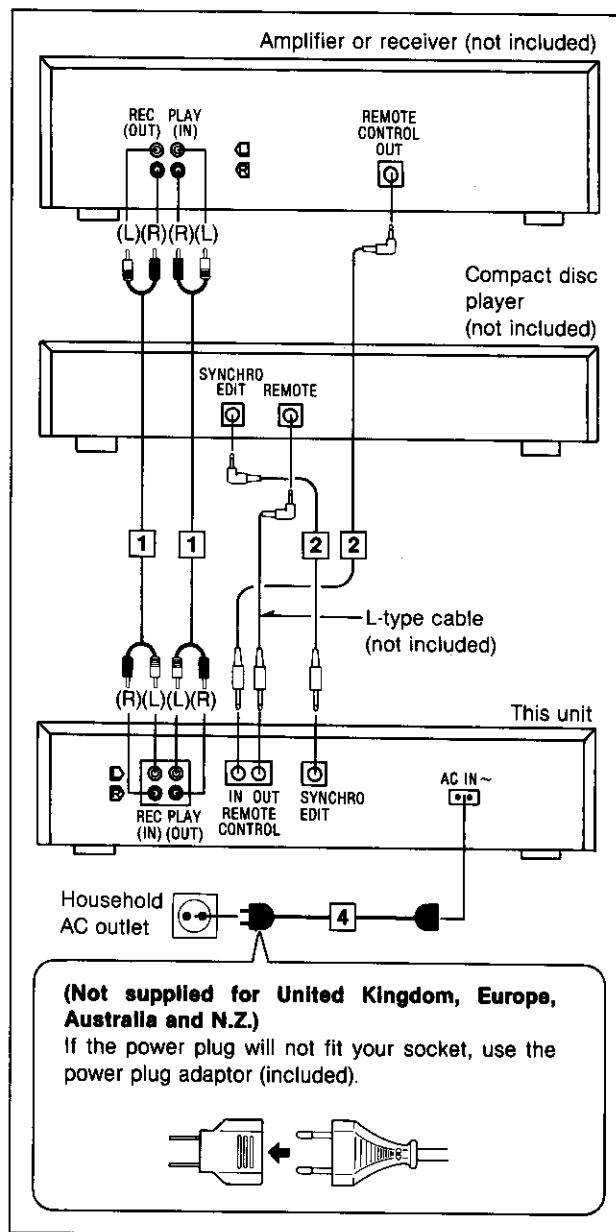

"REMOTE CONTROL IN" terminal

Make a connection from this terminal to the control terminal for a cassette deck with a Technics amplifier or a Technics receiver. (For detailed information, refer to the operating instructions of the Technics amplifier or the Technics receiver.)

"REMOTE CONTROL OUT" terminal

Make a connection from this terminal to the "REMOTE INPUT" terminal of a Technics graphic equalizer or to the "REMOTE" terminal of a Technics compact disc player.

(For detailed information, refer to the operating instructions of the Technics graphic equalizer or the Technics compact disc player.)

"SYNCHRO EDIT" terminal

Make a connection from this terminal to a terminal that has the synchro-edit function of a Technics compact disc player. See page 17. (Contact your dealer for details.)

Front Panel Controls and Functions

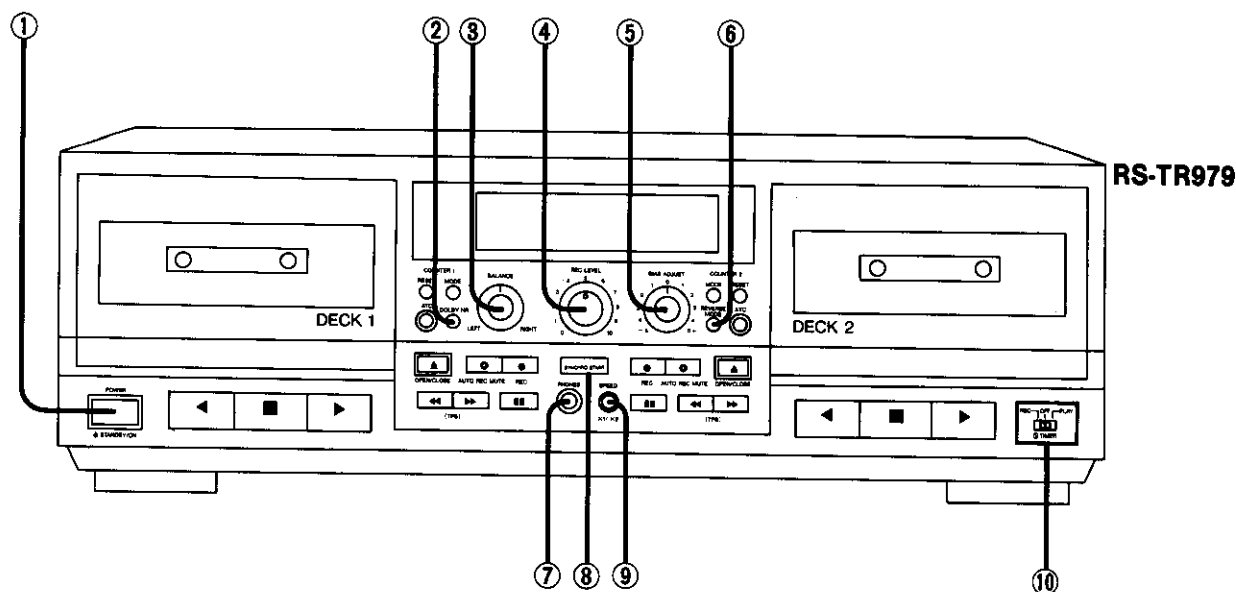

RS-TR979

Control section

Controls common to both tape decks

- ① Power “ ϕ STANDBY/ON” switch (POWER, ϕ STANDBY/ON)**
This switch switches ON and OFF the secondary circuit power only. The unit is in the “standby” condition when this switch is pressed to set it to the ϕ STANDBY mode. Regardless of the switch setting, the primary circuit is always “live” as long as the power cord is connected to an electrical outlet.
- ② Dolby noise-reduction button (DOLBY NR)**
This button is used to reduce the hissing noise heard from the tape. This unit is provided with both the B-type and C-type noise-reduction systems. (See pages 9, 10 and 12.)
- ③ Recording-balance control (BALANCE)**
This control is used to balance the left and right sound levels during recording. (See page 12.)
- ④ Recording-level control (REC LEVEL)**
This control is used to regulate the recording level. (See page 12.)
- ⑤ Bias-adjustment control (BIAS ADJUST)**
This control is used to equalize the frequency response during recording. (See page 14.)
- ⑥ Reverse-mode selector (REVERSE MODE)**
This selector is used for selection of the reverse mode (for either playback or recording). (See pages 9, 10, 12, 15, and 16.)
- ⑦ Headphones jack (PHONES)**
- ⑧ Synchro-start button (SYNCHRO START)**
This button is used to start a tape-to-tape recording, simultaneously starting deck 1 (the playback deck) and deck 2 (the recording deck). (See page 16.)
- ⑨ Tape-to-tape recording-speed button (SPEED)**
This button is used to select the recording speed during tape-to-tape recording. (See page 16.)
- ⑩ Timer switch (\square TIMER)**
This switch is used to automatically begin a tape recording or tape playback at a certain time, selected by an optional timer. (See page 18.)

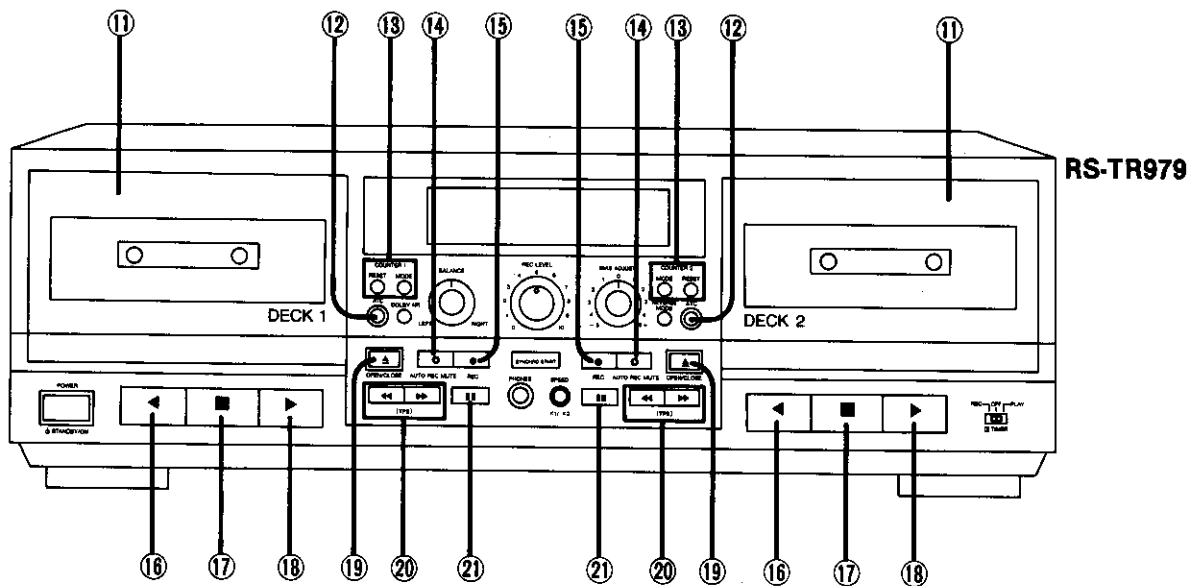

RS-TR979

Controls applicable to tape deck 1 and/or 2

- 11 Cassette holder**
- 12 ATC button (ATC)**
 This button is used to perform ATC (auto tape calibration).
 (See page 13.)
[For RS-TR777: deck 2 only]
- 13 Tape counter buttons (COUNTER 1/COUNTER 2)**
MODE: This button is used to select the tape/linear counter indication.
RESET: This button is used to reset the tape counter indication to "000_" / "00.00".
 (See page 10.)
- 14 Automatic-record-muting button (● AUTO REC MUTE)**
 This button is used to make a silent interval on the tape while recording is in progress. (See page 17.)
[For RS-TR777: deck 2 only]
- 15 Record button (● REC)**
 This button is used to set deck to the recording stand-by mode. (See page 12.)
[For RS-TR777: deck 2 only]
- 16 Reverse-side playback button (◀)**
 This button is used to start the playback or recording of side "B" of the cassette.
 (The tape will move in the right-to-left direction.)
- 17 Stop button (■)**
 This button is used to stop the tape movement.
- 18 Forward-side playback button (▶)**
 This button is used to start the playback or recording of side "A" of the cassette.
 (The tape will move in the left-to-right direction.)
- 19 Open/close button (▲ OPEN/CLOSE)**
 This button is used to open or close the cassette holder.
- 20 Rewind/fast-forward search buttons (◀◀/▶▶ TPS)**
 These buttons are used to advance or rewind the tape, or to easily and quickly search for the program's beginning of the tape. (See page 11.)
- 21 Pause button (||)**
 This button is used to temporarily stop the tape playback or recording.
[For RS-TR777: deck 2 only]

Front Panel Controls and Functions

(continued)

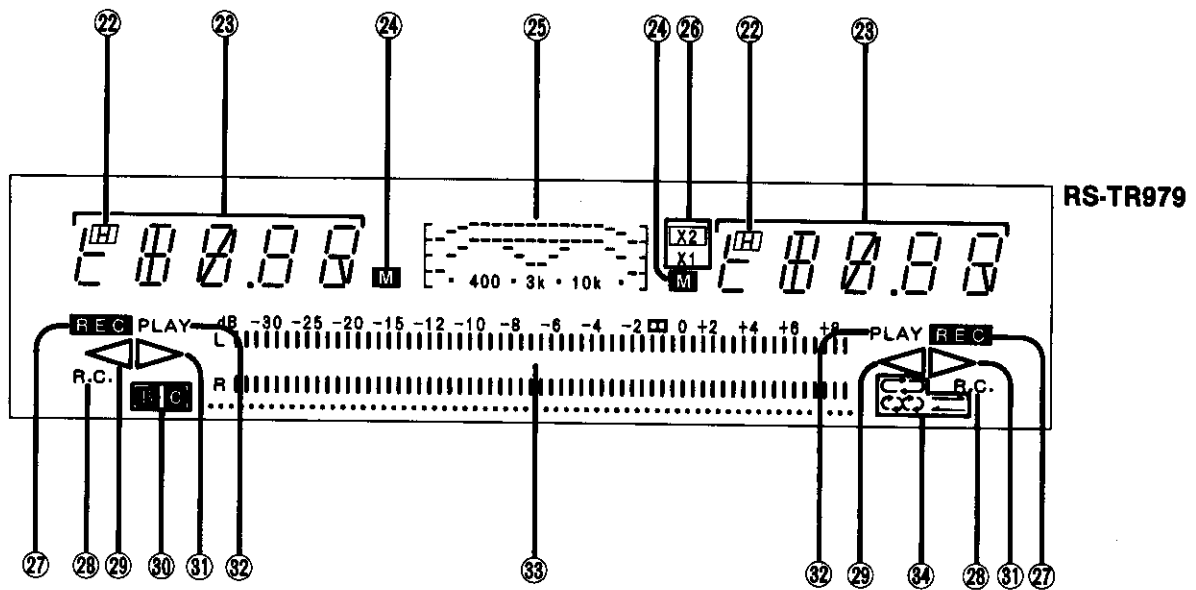

Display section

- 22 High-speed rewind/fast-forward search Indicator (**H**)**
Illuminates during high-speed rewind/fast-forward or high-speed search.
- 23 Tape counter/ATC display**
Normally functions as the tape/linear counter display. During ATC (auto tape calibration), displays the status of the ATC operation.
- 24 ATC memory Indicator (**M**)**
Flashes during ATC (auto tape calibration), and then remains illuminated when the ATC operation is completed.
[For RS-TR777: deck 2 only]
- 25 ATC graphic display**
Shows a graphic display of the ATC (auto tape calibration) operation.
- 26 Tape-to-tape recording-speed Indicators (**x1**, **x2**)**
One of these indicators illuminates to show which of the tape-to-tape recording speeds was selected by pressing the tape-to-tape recording-speed button.
- 27 Recording Indicator (**REC**)**
Illuminates to indicate that this unit is in the recording stand-by mode or is recording.
[For RS-TR777: deck 2 only]
- 28 Remote-control Indicator (R.C.)**
Illuminates to indicate that this unit can now be controlled by the remote control transmitter.
- 29 Reverse-side Indicator (**<**)**
Illuminates during playback or recording to indicate that side "B" of the tape is being used.
- 30 Dolby noise-reduction indicators (**B**, **C**)**
Each indicator illuminates to show the type of Dolby noise-reduction system selected by pressing the Dolby noise-reduction button.
- 31 Forward-side Indicator (**>**)**
Illuminates during playback or recording to indicate that side "A" of the tape is being used.
- 32 Playback Indicator (**PLAY**)**
When this indicator illuminates steadily, it indicates that this unit is in the playback or recording mode.
When flashing, indicates that this unit is in the pause mode or in the recording stand-by mode.
- 33 Input level meter**
During playback, this meter indicates the level of the recorded sound.
During recording, it indicates the level being recorded, adjusted by the recording-level control.
- 34 Reverse-mode indicators (**=**, **↶**, **↷**)**
Each indicator illuminates to show which of the reverse modes was selected by the reverse-mode selector.

Playback (Basic play)

Either normal, CrO₂ or metal type cassettes can be used.

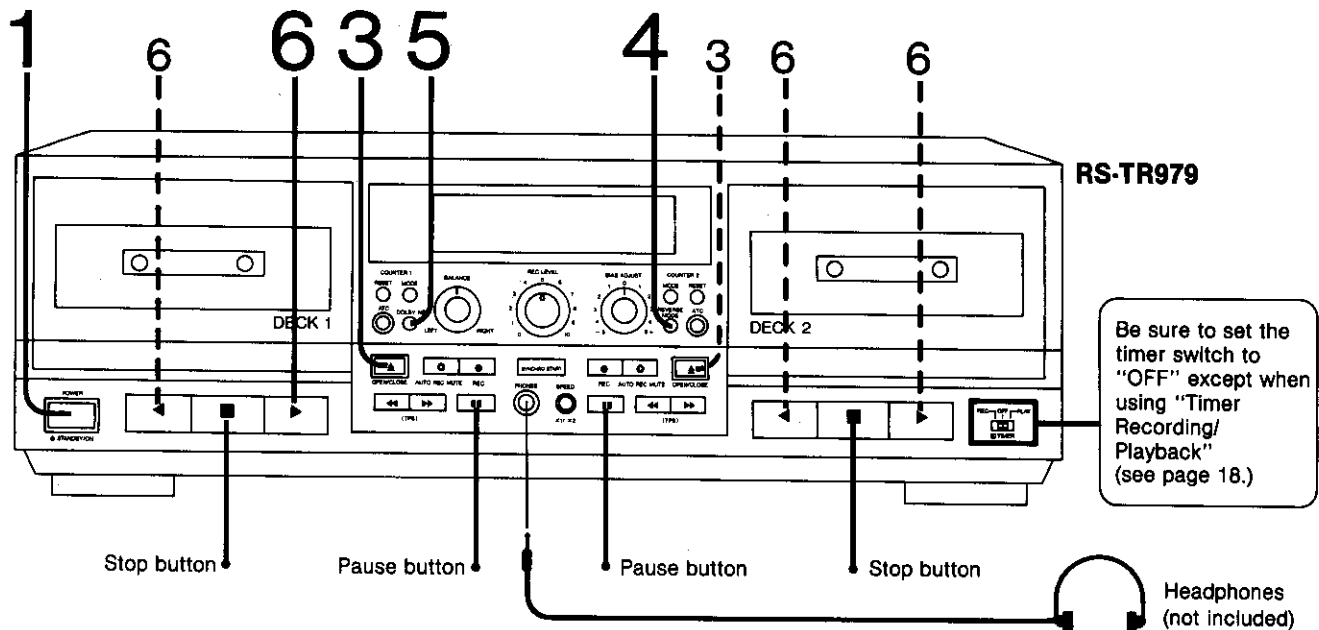

1 Press the power "⏻ STANDBY/ON" switch to turn the unit on.

2 Select the "TAPE" input source on the Amplifier.

3 Press the open/close button for deck 1 and/or deck 2 to be used for playback, and then insert the cassette tape.

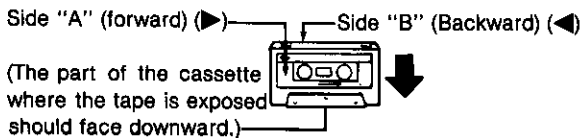

Press again to close the cassette holder.

4 Select the appropriate reverse mode. (Refer to "About the reverse mode" on page 10.)

5 Select the appropriate noise-reduction system (B or C).

Dolby noise-reductions indicator changes in the following way each time the button is pressed. [B] → [C] → (OFF)... Set to "OFF" if neither of the Dolby noise-reduction systems is to be used.

6 Press the playback button.

▶ PLAY: Plays side "A"

◀ PLAY: Plays side "B"

(The playback indicator will illuminate, and playback will begin.)

Notes:

- Deck 1 and deck 2 cannot be used for playback at the same time.
- When either deck 1 or deck 2 is in the playback or tape program search mode, it will stop if a recording or playback is started on the other deck.

■ To temporarily stop playback [For RS-TR777: deck 2 only]

Press the pause button.

(The playback indicator will begin flashing.)

To resume playback, press the pause button again or press the playback button corresponding to the side of the tape being played.

■ To stop playback

Press the stop button.

(The playback indicator will switch OFF.)

To listen through headphones

Connect the headphones (not included) to the headphones jack.

Plug type: 1/4 inch phone plug, stereo type.

Note:



Avoid listening for prolonged periods of time to prevent hearing damage.

About the automatic-tape-select function

This unit is equipped with the automatic-tape-select feature; it automatically detects the type of tape being used, and then makes the suitable adjustments of the bias and equalization accordingly.

Playback (continued)

About the reverse mode

The reverse function on this unit has three modes ( ,  , ). Read the descriptions below and select the mode as desired. (Refer to step 4 on page 9.)

 **Select this mode to play back only one side of a cassette tape.**

(The "" reverse-mode indicator will then illuminate.)
When the playback of the selected side has finished, tape movement will stop automatically.

 **Select this mode to play back both sides of a cassette tape continuously.**

(The "" reverse-mode indicator will then illuminate.)
This playback will continue eight times or until the stop button is pressed.

(One "time" is counted when side "B" of the tape finishes playback. If playback is started from side "B", side "A" will play only seven times.)

 **Select this mode to play back both sides of cassette tapes in decks 1 and 2 continuously. (This is called "series playback".)**

(The "" reverse-mode indicator will then illuminate.)
This mode is convenient for enjoyment of a long period of uninterrupted background music.

Both sides (from side "A" to side "B") of the tape in deck 1 are played first, and then both sides of the tape in deck 2. This playback will continue eight times or until the stop button is pressed. (One "time" is counted when side "B" of the tape in deck 2 finishes playback. If playback is started from deck 2, the tape in deck 1 will play only seven times.)

Likewise, if playback is started from side "B" of the tape in deck 1, side "A" of the tape in deck 1 will be played only seven times.)

About the Dolby noise-reduction recording/playback system

The Dolby noise-reduction system is a system designed to effectively reduce the annoying high-frequency "hissing" noise typically heard from tapes if this system is not used. During recording, the system functions to increase the level of the high-frequency part of the sound, and then, during playback, that same portion is weakened and returned to the previous level.

This unit includes two types of Dolby noise-reduction systems, the Dolby B NR-type and C NR-type.

Dolby B-type noise-reduction

Noise is reduced to about one-third.
Use this system when playing back tapes recorded by the Dolby-B noise-reduction system, such as prerecorded music tapes, etc.

Dolby C-type noise-reduction

Noise is reduced to about one-tenth.
Use this system for the recording and playback of sound sources that have a wide dynamic range and good tone quality, such as FM broadcasts of live performances, etc., and for playing back such tapes.

About the Dolby HX-Pro headroom extension system

By functioning to improve the maximum output level of the tape's high-frequency range, this system permits recordings without a drop of the level of the sound source's high-frequency range. In addition, by using the system in parallel with this unit's noise-reduction system, recording and playback with a greatly extended dynamic range is possible.

Dolby noise reduction and HX Pro headroom extension manufactured under license from Dolby Laboratories Licensing Corporation. HX Pro originated by Bang & Olufsen.

"DOLBY", the double-D symbol  and "HX PRO" are trademarks of Dolby Laboratories Licensing Corporation.

About the tape/linear counter

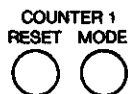

Tape counter buttons
(on both decks)

The "MODE" button is used to select the tape/linear counter indication.

When the "RESET" button is pressed, the indication will be reset to "000_" if the counter is in the tape counter mode, or to "00.00" if the counter is in the linear counter mode.

Tape-counter display

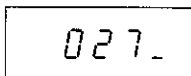

This display shows the amount of tape movement as a series of consecutive numbers.

Linear-counter display

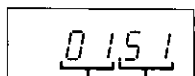

This display shows the amount of tape movement expressed in minutes and seconds.

The linear counter of this unit does not function as a clock. Depending on the length of the tape used, the diameter of the cassette's hubs, etc., there may be a difference between the time displayed by the counter and the actual recording or playback time.

[Difference when an ordinary tape is played on one side from beginning to end]

Cassette type	Approx. difference
C46 (large hub), C60, C90	-30 to +30 seconds
C46 (small hub)	+2 or 3 minutes

The linear counter will display a minus reading if the counter is reset to "0000" and the tape is then rewound.

To locate and play a certain program

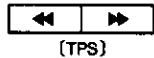

Rewind/fast-forward search buttons
(on both decks)

■ To find the beginning of a program (TPS: Tape Program Search)

Press the rewind/fast-forward search button during playback.

The playback indicator will flash rapidly while in the search mode.

During playback of side "A" (forward) (▷)	▶▶	Press to locate the beginning of the next program.
	◀◀	Press to find the beginning of the recent or a previous program.
During playback of side "B" (reverse) (◁)	▶▶	Press to find the beginning of the recent or a previous program.
	◀◀	Press to locate the beginning of the next program.

After the program's beginning is located, playback will start automatically.

To locate the beginning of a program that is several programs before (or after) the recent program, repeat the search function as many times as necessary.

If the reverse-mode selector setting is "↔" or "↔", the tape will reverse its direction of movement when it reaches its end, and the search will continue on the opposite tape side. (If, after the tape reverses direction, the program is not located, the tape will stop when it reaches its end.)

Note that this feature might not function correctly under the following circumstances:

- If there is noise between programs.
- If the silent interval between programs is less than 4 seconds.
- If there is a particularly low level of sound, or a silent interval, at any place within the programs.
- When less than 10 seconds have elapsed since the beginning of a program, or when there is less than 10 seconds to the beginning of the next program.
- In a section where a fade-in or fade-out has been recorded.

■ To fast-forward or rewind the tape.

Press the rewind/fast-forward search button while in the stop mode.

If side "A" is being played (forward) (▷)	▶▶	Press to fast-forward.
	◀◀	Press to rewind.
If side "B" is being played (reverse) (◁)	▶▶	Press to rewind.
	◀◀	Press to fast-forward.

Cassette tapes in deck 1 and deck 2 can be advanced or rewound at the same time.

While one of the decks is being used to make a recording [from REC (IN)], the other deck can be used for fast-forwarding or rewinding a tape.

High-speed search/rewind/fast-forward

On this unit, if there is less tape on the take-up side than on the supply side (refer to the illustration below) at the time that the rewind/fast-forward search button is pressed, the speed of the search or rewind/fast-forward operation will automatically be increased to approximately twice the normal speed. This function makes it possible to wind the tape faster when there is a large amount of tape to be wound.

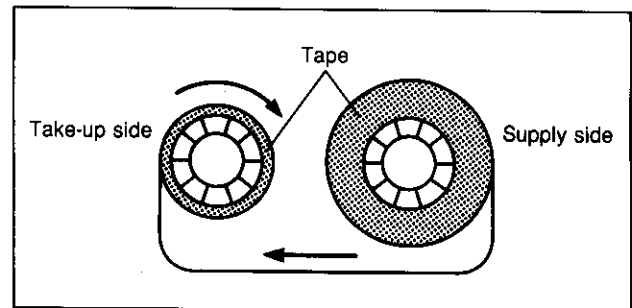

Notes:

- When there is more tape on the take-up side than on the supply side, the tape will be wound at the normal speed. In addition, if high-speed winding is begun from a state in which the tape is partly wound, such as that shown in the illustration above (for example, when the ratio of tape between the two sides is 1:3), high-speed winding will continue until the ratio between the two sides reaches 3:1, and then the remaining winding will be done at the normal speed.
- Once the tape has reached either the end or the beginning, all winding will be performed at high speed. (However, if the open/close button is pressed, the speed for subsequent winding will once again be determined in accordance with the ratio of tape between the two sides.)

To change from high-speed winding to normal-speed winding:

Press the rewind/fast-forward search button while the high-speed winding is in progress. (The winding cannot be subsequently changed back to high-speed winding, even if the button is pressed again.)

Recording

Either normal, CrO₂ or metal type cassettes can be used.

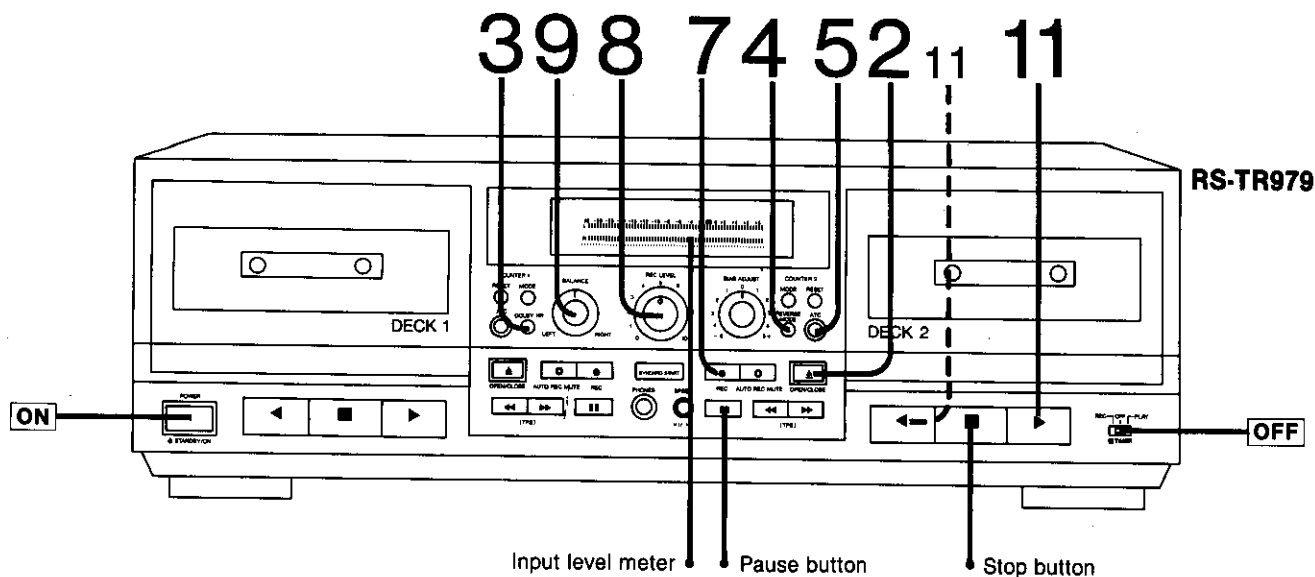

The steps described below are an example for recording on deck 2. To record on deck 1, the corresponding buttons for deck 1 should be used in steps 2, 5, 7 and 11, as well as the corresponding pause and stop buttons.
[On RS-TR777, recording is only possible on deck 2.]

Notes:

- Switch OFF (by pressing the tape-to-tape recording-speed button) whichever tape-to-tape recording-speed indicator that is illuminated. (Refer to step 3 on page 16.)
- If this unit is used in combination with a Technics compact disc player that has a synchro-edit terminal, switch OFF the compact disc edit indicator on the compact disc player (by pressing the stop button on the compact disc player).
- Be sure to set the bias-adjustment control to 0.

1 Select the input source on the Amplifier.

2 Insert the cassette to be used for recording into deck 2.

Recordings cannot be made on the leader tape (attached to each end of recording tape), so advance the tape slightly from its end before starting a recording.

3 Select the Dolby noise-reduction system (B or C) to be used.

Set to "OFF" if neither of the Dolby noise-reduction systems is to be used.

4 Select the appropriate reverse mode ("=" or "↔").

= Select this mode to record on one side only.

↔ Select this mode to record on both sides.

The recording will be made on side "B" after recording on side "A". The tape will stop at the end of side "B".

5 Press the ATC button.

ATC (auto tape calibration) will begin, and will be completed in approximately one minute.

(For detailed information, refer to "About the ATC function" on page 13.)

[Recording is also possible without performing ATC.]

6 The sound source to be recorded should be played before the recording is started in order to adjust the recording level.

7 Press the record button.

(The recording indicator will illuminate and the playback indicator will flash continuously. The unit will be in the recording stand-by mode.)

8 Adjust the recording level.

While watching the level on the input level meter, adjust the "REC LEVEL" control so that the peak indication is as high as possible, without exceeding the indication noted in the chart below.

Normal, CrO ₂ tape	0	Metal tape	+2
-------------------------------	---	------------	----

9 Adjust the left/right recording balance.

10 Stop playback of the source.

11 Start recording, then start playing the source to be recorded from the beginning.

The playback indicator will illuminate steadily, and the recording will begin.

If only one side of the tape (reverse mode position: =) is to be recorded, press the playback button that corresponds to that side.

To record on both sides of the tape (reverse mode position: ↔), press the "A" side playback button (▶).

■ To temporarily stop recording
Press the pause button.

(The playback indicator will begin flashing.)

To resume recording, press the pause button again or press the playback button corresponding to the side of the tape being recorded upon.

■ To stop recording
Press the stop button.

About the ATC function

ATC (auto tape calibration) is the function which identifies the quality of the tape (concerning bias, level, equalizer) automatically and sets the most desirable recording condition. It takes about 1 minute to complete the setting.

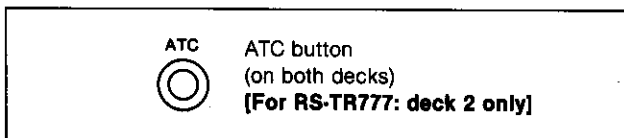

ATC will begin when the ATC button on the deck in which the cassette for recording is inserted is pressed.

Perform ATC while the other deck is in the stop (or rewind/fast-forward) mode.

Because the ATC function records a test signal onto the tape, any previously recorded material will be erased, so be careful not to accidentally erase material which you wish to save.

Although ATC can also be performed for a tape which is partly wound, it is not possible at the end of the tape. Although the tape will be wound back to its original position after ATC has been completed, the position may be slightly different from the exact original position. Therefore, perform ATC 2 seconds or more after the end of the previous track.

Be sure to set the bias adjustment control to 0.

The display changes as follows while the ATC setting is taking place.

Example: Performing ATC on tape deck 2.

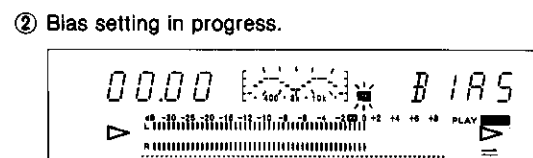
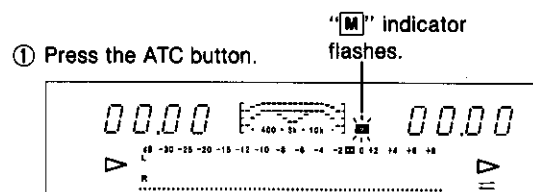

③ Equalizer setting in progress.

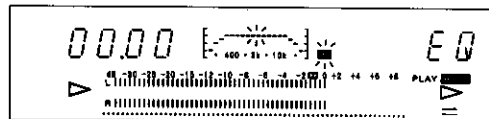

④ Level setting in progress.

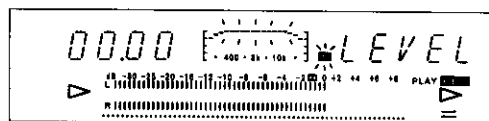

⑤ ATC completed.

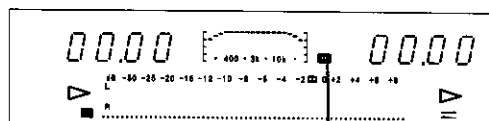

"M" indicator illuminates.

If the leader tape (attached to each end of recording tape) is reached during the above setting operations, the "M" indicator will rapidly flash on and off to indicate that ATC is not possible. Wind the tape to a position from which ATC can be performed and press the ATC button once again.

■ To cancel the ATC function while the settings are in progress

Press the stop button.

■ To cancel the ATC settings after they have been made

Press the ATC button. (The settings cannot be cancelled during recording.)

Notes:

- ATC may not be possible on an old tape or on some special types of tapes.
- The settings will be cancelled if the open/close button is pressed, so do not remove the tape cassette until recording has been completed.
- Unless the ATC settings are cancelled, they will be stored in memory even after the power has been switched to the standby condition (or the AC power supply cord has been disconnected from the AC outlet.)

Recording (continued)

Adjusting the sound characteristics in the high-frequency range

If ATC has been performed, the bias will be automatically adjusted for a flat frequency response (refer to the graph at right). If you wish to change the sound characteristics, use the bias-adjustment control to make the adjustment.

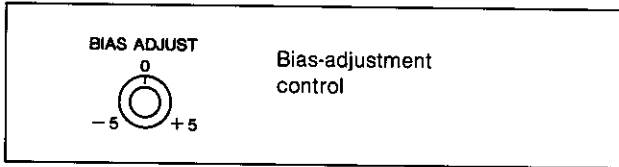

The adjustment will be made more precisely by listening through headphones. Connect the headphones to the headphones jack of the deck or amplifier.

1 Record using the ATC function.

2 Re-wind and then play back the tape.

During playback, listen carefully to the sound characteristics in the high-frequency range.

3 If desired, use the bias-adjustment control to adjust the sound characteristics.

(Refer to "How to adjust the bias" at right.)

The effects of the adjustment cannot be obtained during playback. Re-wind the tape, make the recording again, and then play it back.

4 Repeat step 3 until you have obtained the desired sound characteristics in the high-frequency range.

Notes:

- It is not possible to adjust the bias for metal tape.
- The bias readjustment is not needed as long as you continue to use the same type and brand of tape that was used when the adjustment was first made.

How to adjust the bias

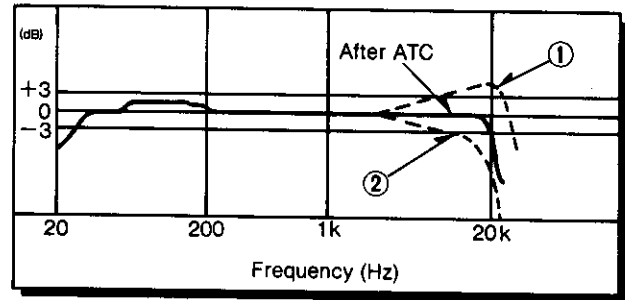
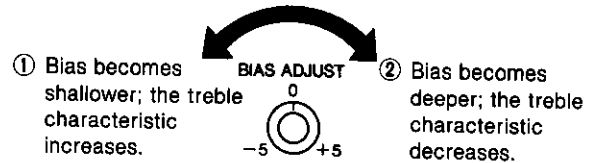

Adjustment of the tape characteristics during recording

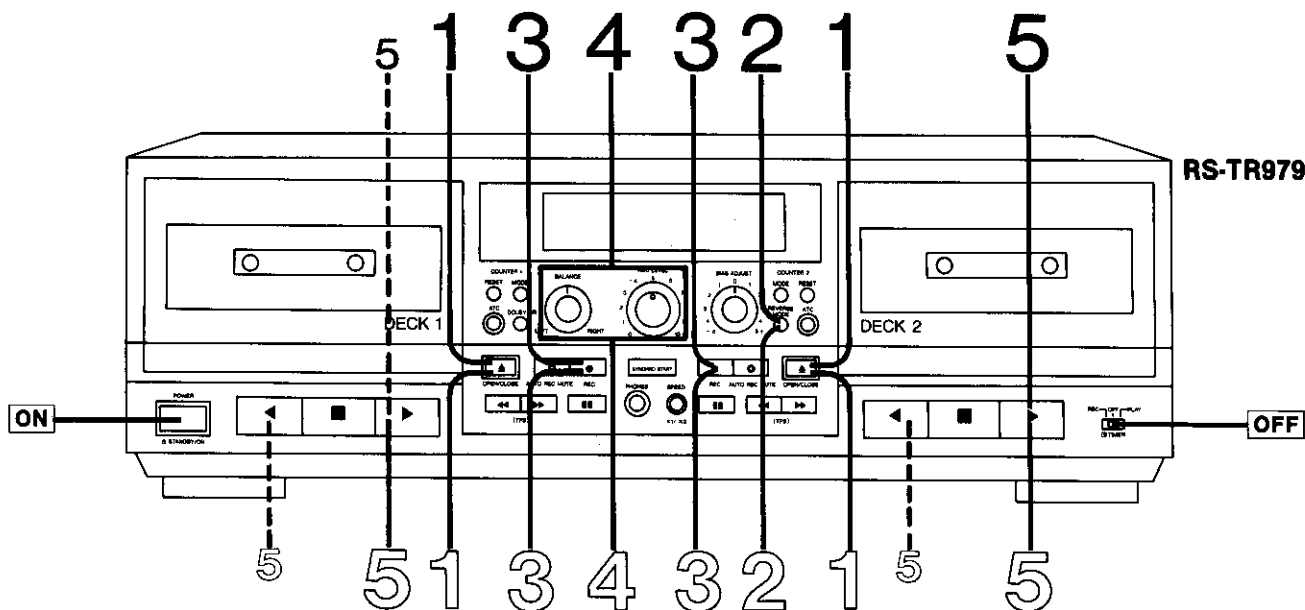

Series recording [RS-TR979 only]

Recordings can be made first on side "A" and then side "B" of the cassette in either tape deck 1 or tape deck 2, and then continued to side "A" and side "B" of the cassette in the other tape deck. This means, for example, if two 90-minute cassettes are used, that a long recording (total length 3 hours) can be made.

1 Insert the cassettes to be used for recording into deck 1 and deck 2.

Be sure that the forward-side indicators (▷) of both tape decks are illuminated. (Press the forward-side playback button, followed immediately by the stop button.)

2 Set the reverse mode selector to the "C" position.

To record using the ATC function, now press the ATC button on deck 2, and then, after the ATC settings have been completed, press the ATC button on deck 1. (See page 13.)

3 Press the record buttons of deck 1 and deck 2.

(Both decks will then change to the recording stand-by mode.)

4 Begin playback of the sound source and adjust the recording level and the left/right recording balance.

(Refer to steps 8 and 9 on page 12.)

After that, stop the play being done so as to adjust the recording level.

5 Press the forward-side playback button (▷) of the first tape deck to be used for recording, and then start playing the source to be recorded from the beginning.

To stop the recording before it has finished, press the stop button(s).

Parallel recordings [RS-TR979 only]

The same sound source can be recorded simultaneously to both deck 1 and deck 2.

1 Insert the cassettes to be used for recording into deck 1 and deck 2.

To avoid making the recording incorrectly, the same direction of tape movement for recording should be selected for each tape deck.

2 Select the side(s) of the tape [one side only (≡) or both sides (↔)] upon which the recording is to be made.

To record using the ATC function, now press the ATC button on deck 2, and then, after the ATC settings have been completed, press the ATC button on deck 1. (See page 13.)

3 Press the record buttons of deck 1 and deck 2.

(Both decks will then change to the recording stand-by mode.)

4 Begin playback of the sound source and adjust the recording level and the left/right recording balance.

(Refer to steps 8 and 9 on page 12.)

After that, stop the play being done so as to adjust the recording level.

5 Press the playback buttons of deck 1 and deck 2 at the same time, then start playing the source to be recorded from the beginning.

(Be sure that they are both for the same direction.)

Notes:

- If you selected recording on both-sides (↔) in step 2, begin recording from side A on both decks.
- Different sound sources cannot be recorded separately on deck 1 and deck 2 at the same time.

Tape-to-tape Recording (from DECK 1 to DECK 2)

Either normal, CrO₂ or metal type cassettes can be used.

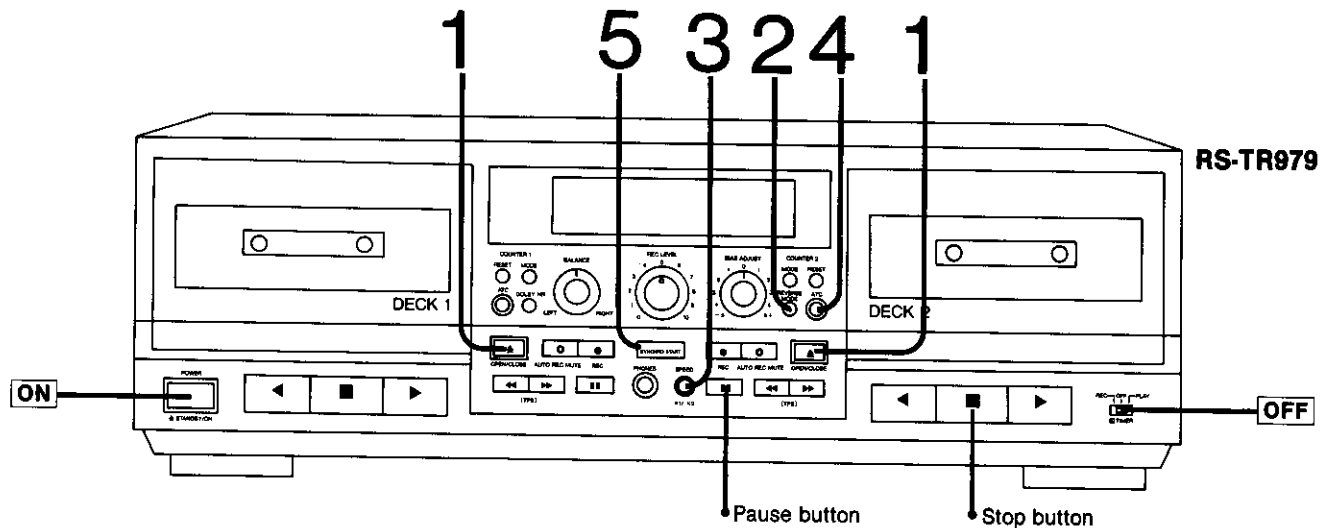

1 Insert the cassette for recording into deck 2. Then insert the cassette for playback into deck 1.

2 Select the appropriate reverse mode.
 [] Select this mode to record on one side only.
 [] Select this mode to record on both sides.

[] The recording will be made on side "B" after recording on side "A". The tape will stop at the end of side "B".
In the " [] " mode:
 In case the length of a tape set in the deck 2 is longer than a tape in the deck 1, the deck 1 repeats the playback until the deck 2 complete the recording on both sides. (up to eight times)

3 Select the speed at which the recording will be made.

[The tape-to-tape recording-speed indicator ("x1" or "x2") will illuminate.]

- x1 : For operation at the normal tape speed
- x2 : For operation at the high tape speed

4 Press the ATC button of deck 2.
 ("M") indicator flashes.

ATC will not begin until the next step is executed.
 [Recording is also possible without performing ATC.]

5 Press the synchro-start button.

ATC (refer to page 13) will begin, and when it is completed, recording will begin.

- In order to avoid mis-operations later, be sure to switch OFF the tape-to-tape recording-speed button (the tape-to-tape recording-speed indicator will go off) after the tape-to-tape recording has finished.

To temporarily stop tape-to-tape recording (deck 2 only)

Press the pause button of deck 2.

The playback indicator of deck 2 will begin flashing, and playback will continue on deck 1.

To resume recording, press the pause button again or press the playback button of deck 2 corresponding to the side of the tape being recorded upon.

To stop a tape-to-tape recording

Press the stop button of deck 2.

To omit unwanted material during tape-to-tape recording

- 1) Press the pause button of deck 2.
- 2) Press the pause button again or press the playback button of deck 2 corresponding to the side of the tape being recorded, when the tape in deck 1 reaches the point where you want to resume recording.

To locate a certain tune while in the tape-to-tape recording mode

- 1) Press the stop button of deck 1.
 A silent interval of about 4 seconds will then be made on the tape in deck 2, and then deck 2 will change to the recording stand-by mode.
- 2) Press the playback button and then press the rewind/fast-forward search button of tape deck 1 to locate the desired program.
 Repeat this step until the desired program is located.
- 3) To resume recording, press the synchro-start button.

Notes:

- Tape-to-tape recordings cannot be made from deck 2 to deck 1.
- Recording level as well as equalizer effects and Dolby noise-reduction effects are recorded on to the tape in deck 2 exactly as they were originally recorded on the tape in deck 1.
- Because noise-reduction effects cannot be heard in the playback sound, when listening to a tape recorded by employing noise-reduction use the treble tone control on the amplifier to reduce the treble range.
- While a tape-to-tape recording is in progress, you can also enjoy some other source. Select the desired sound source by using the input selectors on the amplifier, and start the performance.

Your attention is drawn to the fact that recording pre-recorded tapes or discs on other published or broadcast material may infringe copyright laws.

Convenient Features for Recording

Compact disc synchro-edit-recording (deck 2 only)

When a Technics compact disc player with the compact disc synchro-edit function is used in combination with this unit, recordings can be made on side "A" and side "B" of the tape, without interruption of tracks, in conjunction with the tape length.

[Only for RS-TR979]

The synchro-edit recording function can be accomplished by deck 2 only. Therefore, series recording and parallel recordings are not possible while in this function.

- 1 Prepare for recording on this unit.**
Follow steps 1 through 9 in the section concerning recording. (See page 12.)
Check to be sure that side A (▷) indicator is illuminated.

- 2 Procedure for the compact disc player.**
 - 1. Press the stop button.** (Disc play will stop.)
 - 2. Press the edit-tape-length button and specify the length of the tape to be used.**
The tracks to be recorded to side "A" of the tape and those to be recorded to side "B" will then be automatically selected according to the tape's length.
 - 3. Press the play button.**
The recording will start at the same time that play starts on the compact disc player.

For more detailed information, refer to the operating instructions of the Technics compact disc player to be used.

Notes:

- If the CD program contents to be recorded on side "A" of the tape are shorter than the actual tape length, this unit will continue to record until it reaches the end of side "A", while the compact disc player switches to the pause mode. At the end of side "A", deck 2 automatically switches to side "B" and after a few seconds the compact disc player will resume play.
- When canceling the synchro-edit recording mode, press the stop button on the compact disc player and then press the stop button on this unit. (To cancel mid-way through a performance, press the stop button on the compact disc player twice in succession.)
- Recordings cannot be made on the leader tape (attached to each end of recording tape), so advance the tape slightly from its end before starting a recording.

If the amplifier and CD player are connected with an optical cable:

When using the synchro-edit function, connect the amplifier and CD player again with the stereo connection cables (not supplied).

Automatic-record-muting function

By simply pressing the Automatic-record-muting button while a recording is being made, a silent interval (which is necessary for locating the beginning of a program during playback) can be made.

This feature is also convenient for omitting unwanted material such as commercial messages, etc. during recording.

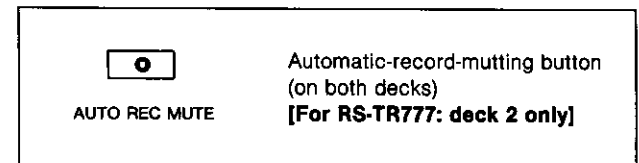

While recording, press the automatic-record-muting button one time.

To resume recording, press the playback button corresponding to the side being recorded.

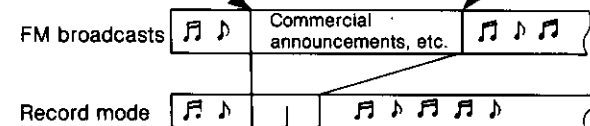

This unit will record a silent interval (4 seconds long) between programs, and then will change to the recording stand-by mode.

■ To make a silent interval of more than 4 seconds

Press and hold the automatic-record-muting button for the necessary number of seconds.

The unit will change to the recording stand-by mode when the button is released.

Timer Recording/Playback

If this unit and the receiver (or tuner) are connected to an audio timer, recording of a radio broadcast, or tape playback, will automatically begin at the preset time. Timer recording or playback is also possible by using a tuner with the timer. Connect the AC power cord of this unit to the power source outlet of the timer. (See the operating instructions of the timer for detailed information.)

Timer recording

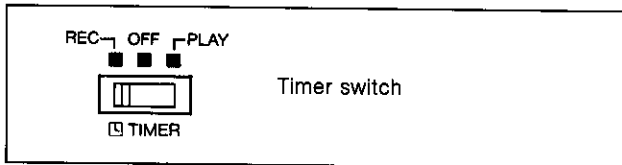

On RS-TR979, timer recording is possible on either deck. If there are cassettes in both deck, series recording or parallel recordings will start. (See page 15.)

Note: Always take out cassettes which are not being used for recording out of the deck.

1 Prepare for recording.

Follow steps 1 through 10 of "Recording" on page 12. After adjusting the recording level and left/right balance, press the stop button. Select the tape side "A (▶)" or "B (◀)" to be recorded. (Press the forward-side or reverse-side playback button, followed immediately by the stop button.)

2 Set the timer to the desired recording-start time.

(Power will be switched OFF.)

3 Set the timer switch to the "REC" position.

(At the specified time, the power will be switched ON and the audio source will be recorded.)

When timer recording has ended, set the timer switch to "OFF".

Timer playback

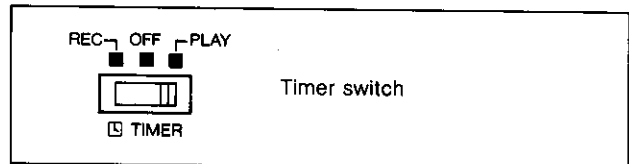

Timer playback is possible on either deck. If there are cassettes in both decks, deck 1 will have priority.

Series playback (deck 1 to deck 2) is also possible. (See page 10.)

1 Rewind the tape to the position from which you want playback to begin

(See page 11.)

Select the tape side "A (▶)" or "B (◀)" to be played back. (Press the forward-side or reverse-side playback button, followed immediately by the stop button.)

2 Set the timer to the desired playback-start time.

(Power will be switched OFF.)

3 Set the timer switch to the "PLAY" position.

(At the specified time, the power will be switched ON and the playback will begin.)

When timer playback has ended, set the timer switch to "OFF".

After Recording

To prevent erasure of recorded sounds

Remove the tab(s).

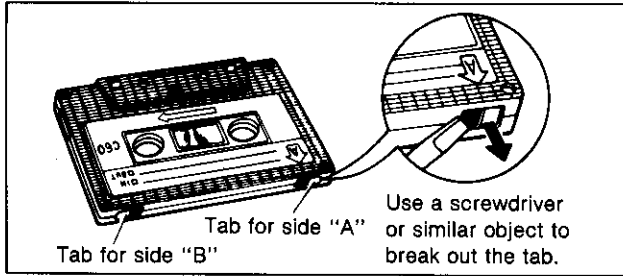

■ To re-record on a protected cassette

Bluck up the hole by adhering a piece of cellophane tape to the area where the safety tab was broken out.

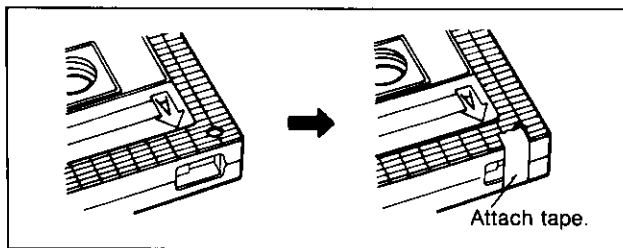

To erase recorded sounds

When new recordings are made on a pre-recorded tape, all sounds recorded on that portion of the tape are automatically erased. To erase a tape without making a new recording, follow the steps below.

- 1 Insert the recorded cassette into the cassette holder of either deck (deck 2 for RS-TR777).
- 2 Set the recording-level control to "0".
- 3 Set the reverse-mode selector to either one-side only (⇐) or both sides (↔).
- 4 Set the Dolby noise-reduction button to OFF. (The Dolby noise-reduction indicator will then switch OFF.)
- 5 Press the record button.
- 6 Press the playback button corresponding to the side to be erased.

About the Quick-Reverse Function

[RS-TR979 only]

This is a function by which the unit detects the leader tape (the transparent tape at both ends of the magnetic tape) and then automatically reverses (in about one second) the direction of the tape during playback (or recording).

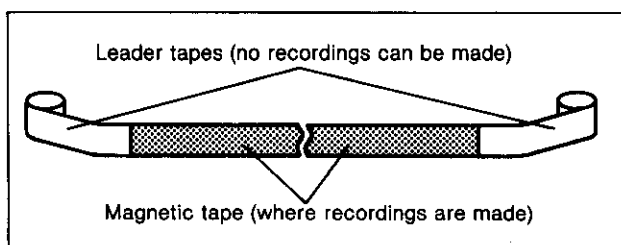

- In order to avoid an operational error at the beginning of the tape, this function is not effective until about 15 seconds after playback (or recording) first starts.
- This function does not operate for tapes that do not have leader tapes.
- This function may not function correctly:
 - If the leader tapes are colored.
 - If there is dirt or dust on the tape.
 - If the magnetic part of the tape is thin.
 - If a strong light (direct sunlight, a spotlight, etc.) is shining into the cassette holder.
 - When the unit is subjected to a strong impact.
- When the quick-reverse function is not activated, the tape's direction of movement will reverse when the tape reaches its end.

About Cassette Tapes

Avoid the following types of tapes

- **Cassette tapes exceeding 90 minutes**
These tapes are handy for their long playback and recording time but be careful about repeatedly stopping and starting, rewinding and fast forwarding these tapes in short intervals as they are thin, tend to stretch and may become entangled in the machine.
- **Fe-Cr tapes (TYPE III)**
The high frequency range will be emphasized, and a flat frequency response characteristics cannot be obtained.
- **Metal tape without detection holes in the cassette**
Recordings will be very distorted. (There is no playback problem, however.)

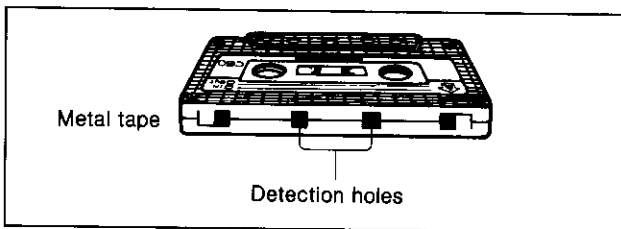

Notes about the handling of cassettes

If the tape in the cassette is loose, the tape can easily break during use or otherwise be damaged. Never touch the tape itself, or attempt to pull it out of the cassette.

Use a pencil or similar object to take up the slack.

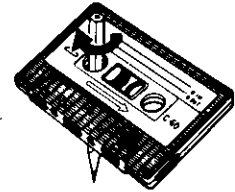

Avoid tape storage in the following place

Tapes can be damaged if it is stored in places such as described below.

- Where the temperature is high (95° F/35° C or higher) or where the humidity is high (80% or higher).
- Where there is a strong magnetic field (near a speaker, on top of a TV, etc.).
- In direct sunlight.

Maintenance

Head care

To assure good sound quality for recording and playback, be sure to clean the heads after approximately every 10 hours of use.

- 1) Press the open/close button to open the cassette holder.
- 2) Disconnect the AC power supply cord from the AC outlet.
- 3) Clean the heads, pinch roller and the capstan shaft of each deck with a cotton swab (or with a soft, lint-free cloth) slightly moistened with alcohol.

Do not use any solution other than alcohol for head cleaning.

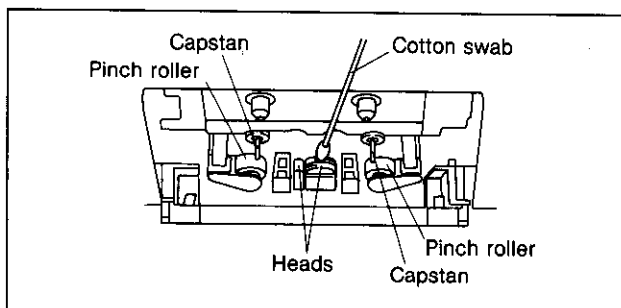

Head demagnetization

In order to maintain good sound quality during recording and playback, it is recommended that the heads should be demagnetized if distortion or poor sound quality persist after cleaning the heads. If the heads become magnetized they could create noise in recordings, loss of high-frequency response, or erasure of valuable recordings. Several types of head demagnetizers are available and may be purchased at local electronics supply stores. Follow the instructions that are supplied with the device.

- Do not bring any type of metal objects or tools such as magnetic screwdrivers in contact with the head assembly.

Maintenance of external surfaces

To clean this unit, use a soft, dry cloth.

For very dirty surfaces, dip a soft cloth in a weak soap-and-water solution and wring well. After cleaning, wipe with a soft, dry cloth. Never use alcohol, paint thinner, benzene, nor a chemically treated cloth to clean this unit.

Such chemicals may damage the unit's finish.

Troubleshooting Guide

Before requesting service for this unit, check the chart below for a possible cause of the problem you are experiencing. Some simple checks or a minor adjustment on your part may eliminate the problem and restore proper operation.

If you are in doubt about some of the check points, or if the remedies indicated in the chart do not solve the problem, refer to the directory of Authorized Service Centers (enclosed with this unit) to locate a convenient service center, or consult your Technics dealer for instructions.

Problem	Probable cause(s)	Suggested remedy
Tape moves but no sound is heard.	The volume control of the amplifier is set to its minimum position.	• Adjust the volume control to the desired level.
	The input selector of the amplifier is not set to the "TAPE" position.	• Set to the "TAPE" position.
Distorted sound.	The recording level is too high.	• Select the appropriate recording level.
Previously recorded sound has not been erased.	Erase head is dirty.	• Clean the head.
Sound output is hoarse or unsteady.	Heads are dirty.	• Clean the heads.
	Tape is damaged.	• Try operation with a new cassette; if there is no problem with the new cassette, discard the damaged cassette.
Poor sound quality (especially in the high treble and low bass ranges).	The correct Dolby noise-reduction button is not set.	• Set it to the correct position.
Sound is low, poor tone, intermittent sound, noise.	Heads, capstan and/or pinch roller are dirty or tape is damaged.	• Clean the heads, capstan and/or pinch roller, or try a new cassette.
A "hum" noise is heard during tape playback or recording.	This unit is placed too close to a receiver, amplifier or tuner.	• Leave as much space as possible between the units, or place them where there is the least amount of "hum".
Recording is not possible.	The recording level control is at the "0" position.	• Select the appropriate recording level.
	One of the tape-to-tape recording-speed indicators is illuminated.	• Switch OFF (by pressing the tape-to-tape recording-speed button) whichever tape-to-tape recording-speed indicator that is illuminated.
The tape deck does not respond to the synchro-edit function.	The synchro-edit cable is not connected to the compact disc player.	• Connect the synchro-edit cable to the compact disc player.
	The audio cables are not connected.	• Connect the audio cables to the receiver.

Technical Specifications

■ CASSETTE DECK SECTION

Deck system	Stereo cassette deck
Track system	4 track, 2 channel
Recording system	AC bias
Bias frequency	80 kHz
Erasing system	AC erase

Heads

DECK 1

[RS-TR979] Recording/Playback head (Permalloy) × 1

[RS-TR979] Erasing head (Double-gap ferrite) × 1

[RS-TR777] Playback head (Permalloy) × 1

Recording/Playback head (Permalloy) × 1

Erasing head (Double-gap ferrite) × 1

DECK 2

Motors

DECK 1

Capstan/reel table drive (DC servo motor) × 1

Reel table drive (DC motor) × 1

DECK 2

Capstan/reel table drive (DC servo motor) × 1

Reel table drive (DC motor) × 1

Tape speed

4.8 cm/sec. (1-7/8 ips)

Wow and flutter

0.07% (WRMS)

±0.2% (DIN)

Fast forward and rewind times

Approx. 45 seconds with C-60 cassette tape

Frequency response (Dolby NR off)

NORMAL

40 Hz—15 kHz, ±3 dB

20 Hz—16 kHz (DIN)

CrO₂

40 Hz—15 kHz, ±3 dB

20 Hz—16 kHz (DIN)

METAL

40 Hz—16 kHz, ±3 dB

20 Hz—17 kHz (DIN)

S/N (Signal level = max recording level, CrO₂ type tape)

NR off

56 dB (A weighted)

Dolby B NR on

66 dB (A weighted)

Dolby C NR on

74 dB (A weighted)

Input sensitivity and impedance

REC (IN)

100 mV/47 kΩ

Output voltage and impedance

PLAY (OUT)

500 mV/500 Ω

HEADPHONES

37.5 mV/(8 Ω)

(Load impedance 8 Ω—600 Ω)

■ GENERAL

Power consumption

[RS-TR979] 28 W

[RS-TR777] 25 W

Power supply

For United Kingdom, Europe, Australia and N.Z.

AC 50 Hz/60 Hz, 230V—240V

For others

AC 50 Hz/60 Hz, 110 V/127 V/220 V/240 V

Dimensions (W × H × D)

[RS-TR979] 430 × 145 × 280 mm

[RS-TR777] 430 × 135 × 280 mm

Weight

[RS-TR979] 5.3 kg

[RS-TR777] 4.9 kg

Note:

Specifications are subject to change without notice.

Weight and dimensions are approximate.

This apparatus was produced to BS 800.

Memo

Matsushita Electric Industrial Co., Ltd.
Central P.O. Box 288, Osaka 530-91, Japan